

THE PROPERTY OF THE DRAWING IS ESTABLISHED BY LAW. IT IS FORBIDDEN TO PRODUCE OR SHOW IT TO THIRD PARTY, WITHOUT A WRITTEN AGREEMENT.

Item	Name	Q.ty
1	CA.WSL.GA.16	1
2	R.05.12	1
3	R.5.SCH	2
4	V.TCE5x25	2
5	CA.GWP.5.12	1

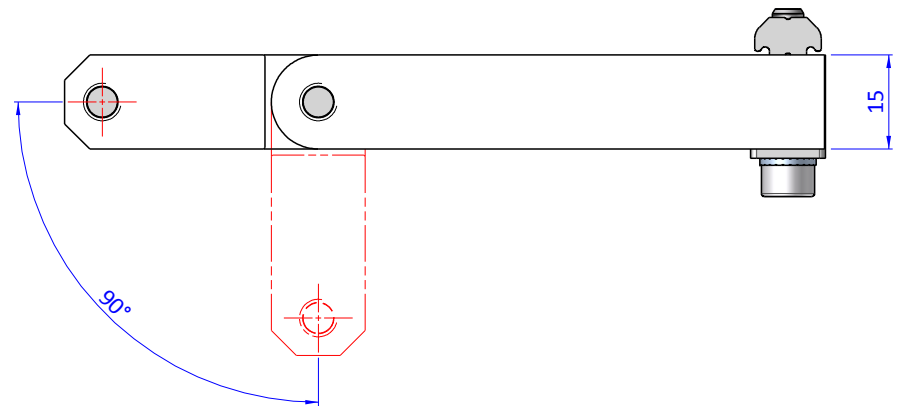
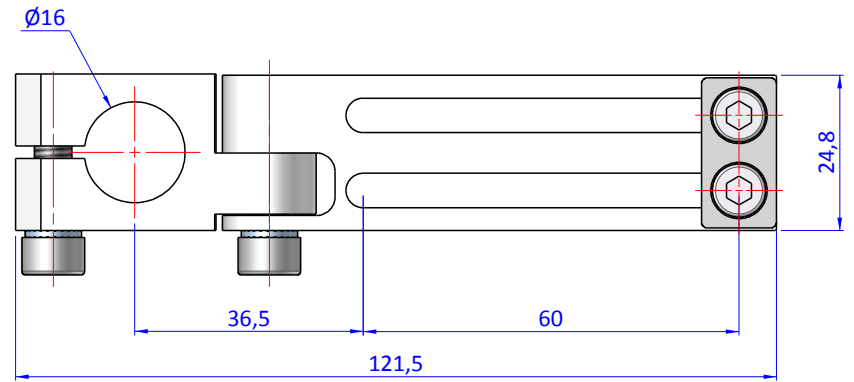
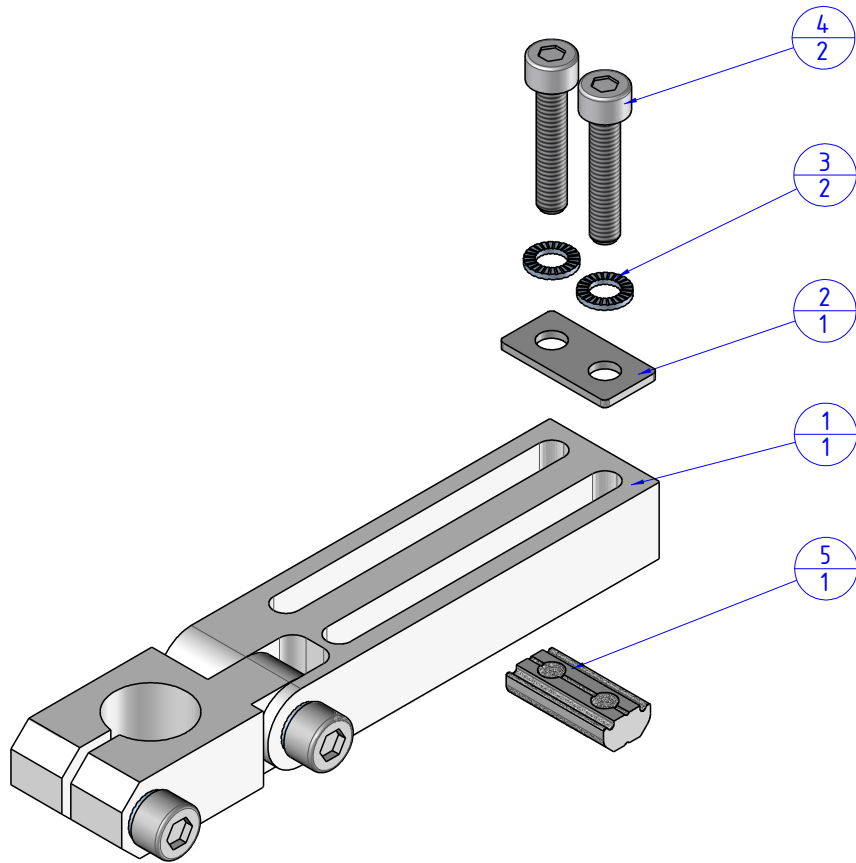

Format A3

UNI 936-76

		DESIGNED FROM	REVIEW
		FP SERVICES	A
GENERAL TOLERANCE	DESCRIPTION	DATE	WEIGHT
UNI - ISO 2768	CA.WSL.GA.16.X	16/11/2018	0,119kg
CLASSE f		CODE	CA.WSL.GA.16.X